

WOOD STOVE BY



THE GREAT INDOORS



TAHOMA

SPECIFICATIONS

DIMENSIONS

Firebox Capacity	2.1 cu.ft.
Maximum Burn Time	7-9 hours
EPA Emissions	3 gr/hr
Weight	310 lbs.
Height	30-5/16"
Width	25-7/8"
Depth (from stove face)	23-3/8"
Maximum Log Length	20"



CLEARANCES

		US Single Wall Connector	US Double Wall Connector	Canada Single Wall Connector	Canada Double Wall Connector
A	Flue to back wall	14-1/4"	12"	14-1/4"	12"
B	Stove back to wall	11-5/8"	9-3/8"	11-5/8"	9-3/8"
C	Flue to side wall	22-1/2"	19"	22-1/2"	19"
D	Stove side to wall	13-3/16"	9-5/8"	13-3/16"	9-5/8"
E†	Door opening/hearth pad	8"	8"	8"	8"
F	Stove back corner to wall	9"	6"	9"	6"
G	Corner, flue to wall	18"	15"	18"	15"
H	Hearth pad depth	37-7/16"	37-7/16"	47-7/16"	47-7/16"
J	Hearth front to back wall	49"	46-3/4"	51"	48-3/4"
K	Hearth pad width	34-3/4"	34-3/4"	40-7/8"	40-7/8"
L	Stove door to hearth front	16"	16"	18"	18"
M	Stove back to hearth back	0"	0"	8"	8"
N	Ceiling height	96"	96"	96"	96"
P	Corner, hearth pad depth	61-1/2"	57-5/16"	63-1/2"	59-5/16"

† USA = 8" (200mm) from door opening
Canada = 8" (200mm) from sides and back of unit

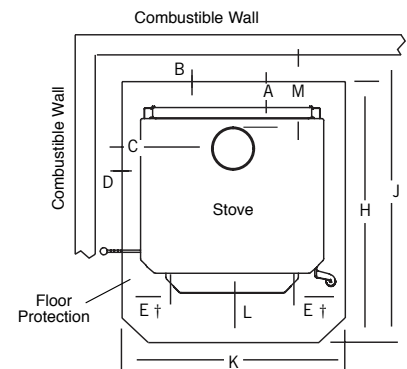
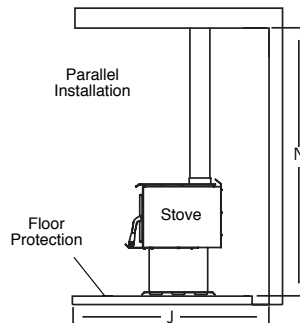
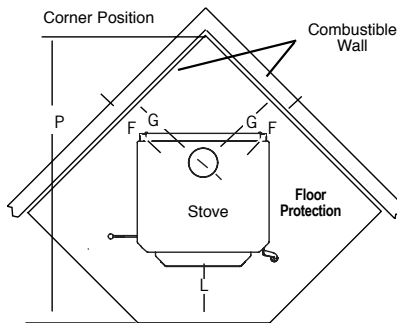

IMPORTANT NOTES:

AS WITH ANY HEATING APPLIANCE, FIREPLACE OR STOVE, THIS APPLIANCE IS EXTREMELY HOT DURING OPERATION. READ AND UNDERSTAND ALL OPERATING INSTRUCTIONS BEFORE USING THIS APPLIANCE. FOR FURTHER INFORMATION, CONSULT YOUR DEALER. ACTUAL PERFORMANCE MAY VARY DEPENDING UPON HOME DESIGN AND INSULATION, CEILING HEIGHTS, CLIMATE, CONDITION AND TYPE OF WOOD USED, APPLIANCE LOCATION, BURN RATE, ACCESSORIES CHOSEN, CHIMNEY INSTALLATION AND HOW THE APPLIANCE IS OPERATED. DIAGRAMS, ILLUSTRATIONS AND PHOTOGRAPHS ARE NOT TO SCALE—CONSULT INSTALLATION INSTRUCTIONS. PRODUCT DESIGNS, MATERIALS, DIMENSIONS, SPECIFICATIONS, COLORS AND PRICES ARE SUBJECT TO CHANGE OR DISCONTINUANCE WITHOUT NOTICE.



© 2015 Innovative Hearth Products

785487M 01/15

Visit us online



IronStrike.us.com

